

ABT-EM Trapdoor ElectriMask Electriscreen

OWNER'S MANUAL



To the Owner
Installation Instructions
Operating the Screen
Maintenance

ABT-EM-1005

TO THE INSTALLER: BE SURE TO LEAVE THIS MANUAL WITH THE OWNER.

Printed in U.S.A.
©2002 - 2005 Stewart Filmscreen Corporation

Stewart Filmscreen reserves the right to make changes to the product specified in this document.

From time to time, this document is updated. Current versions of documentation are posted on the Stewart Filmscreen website at www.stewartfilm.com.

ABT-EM Trapdoor ElectriMask Electriscreen

O W N E R ' S M A N U A L

Contents

To the Owner	2
Preparing the Installation	3
Step 1. Hanging the Case	5
Step 2. Electrical Hook-up	6
Operating the Screen	13
Adjusting the Screen Extension	14
Screen Care and Cleaning	16
Troubleshooting	18

Congratulations on your purchase of the finest optical viewing screen available anywhere in the world!

Please take a moment to review this manual, it will help ensure you many years of trouble-free service from your new Stewart Filmscreen product.

About your ABT-EM Trapdoor ElectriMask Electriscreen

Your ABT-EM ElectriMask Electriscreen offers the most technologically advanced trapdoor roller screen in the world. The hingeless door is powered by its own motor. Sound dampers ensure quiet operation.

The ElectriMask system is designed to integrate with the latest multi-format video projectors, which are capable of variable sizes and aspect ratios for viewing standard broadcast television and the wide format seen in commercial theaters (“letterbox”). The term aspect ratio refers to the format (width to height) in which your home cinema sources are produced.

Your screen is equipped with either a vertical masking system to achieve a 1.33:1 aspect ratio (see Figure 1) or a horizontal masking system to achieve a 1.85:1 aspect ratio (see Figure 2).

Figure 1: Vertical masking system

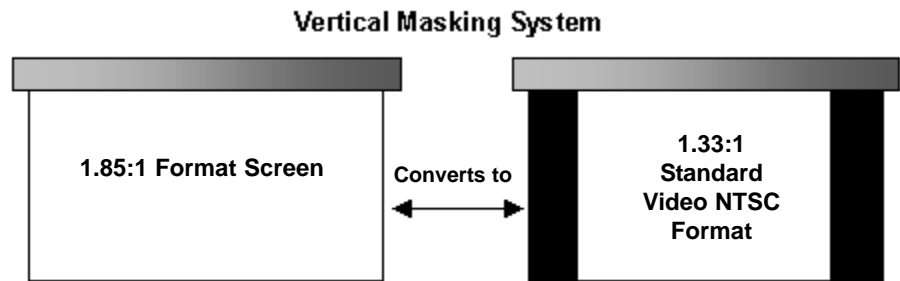
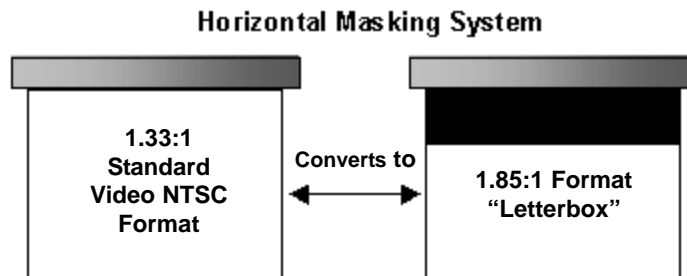

Figure 2: Horizontal masking system



PREPARING THE INSTALLATION

- ◆ **Before proceeding with the installation of this screen, take time to thoroughly read and understand these installation and operation instructions.**
- ◆ **All electrical wiring installations must conform to local and national codes and should be performed by qualified service personnel.**
- ◆ **There are no user-serviceable parts contained within the unit.**

Preparation

Specifications regarding the individual screen dimensions, weight, mounting type, and controls are provided by the factory when the unit is ordered. Before beginning the installation:

- ◆ Check the specifications for the type of mounting and switch control to be used.
- ◆ Ensure that the mounting area and electrical connection are prepared.
- ◆ Check the size and weight of the screen to be installed so that you can plan for the number of people required for the mounting procedure. You need at least two people to mount the smaller screens; more are needed for larger, heavier screens.

You will need:

- ◆ Enough ladders for the personnel supporting the screen during the mounting process
- ◆ A level
- ◆ Fasteners appropriate for the surface on which the screen is being mounted (See instructions for the type of mount for recommendations.)
- ◆ A 5/32" (.4 cm) hex head or Allen wrench

Caution

During installation, do not place the unit on an unstable cart, stand, table, or ladder. The unit may fall, causing injury to a child or adult and damage to the unit.

Unpacking

1. DO NOT remove the paper hanging from the trapdoor at this time. You should remove it only after the unit is hung, all electrical connections have been made, and the screen is in operation.
2. When moving the unit, make sure not to torque or twist the case. This can cause door alignment problems.

Factory Advisory

The factory advises against installing a concealed or recessed electrical projection screen permanently. You must be able to access the external end plates should future service to the internal roller tube/screen assembly system be necessary.

STEP 1. HANGING THE CASE

Professional mounting techniques should be used. Stewart Filmscreen Corporation cannot be liable for substandard or faulty installations.

Make sure that you mount the screen so that the electrical box is on the left side (audience left).

Installing the unit

The ABT-EM Electriscreen is ready to install into the ceiling or soffit. A false ceiling is not intended to support the weight of an ABT-EM Electriscreen.

The screen can be bolted directly to the support structure or suspended. If the unit is to be mounted to plaster, drywall, masonry, or other type of surface, use an appropriate fastener.

1. Install the unit onto the support structure making sure that the bottom of the case is flush with the finished ceiling.
2. Make sure the unit is level.
3. Make sure the case is not twisted or torqued lengthwise when installed. (This can cause door alignment problems and microswitch shutoff failure.)
4. Drywall or other ceiling material may be screwed directly to the ceiling flanges on the case. Refer to Figure 3.

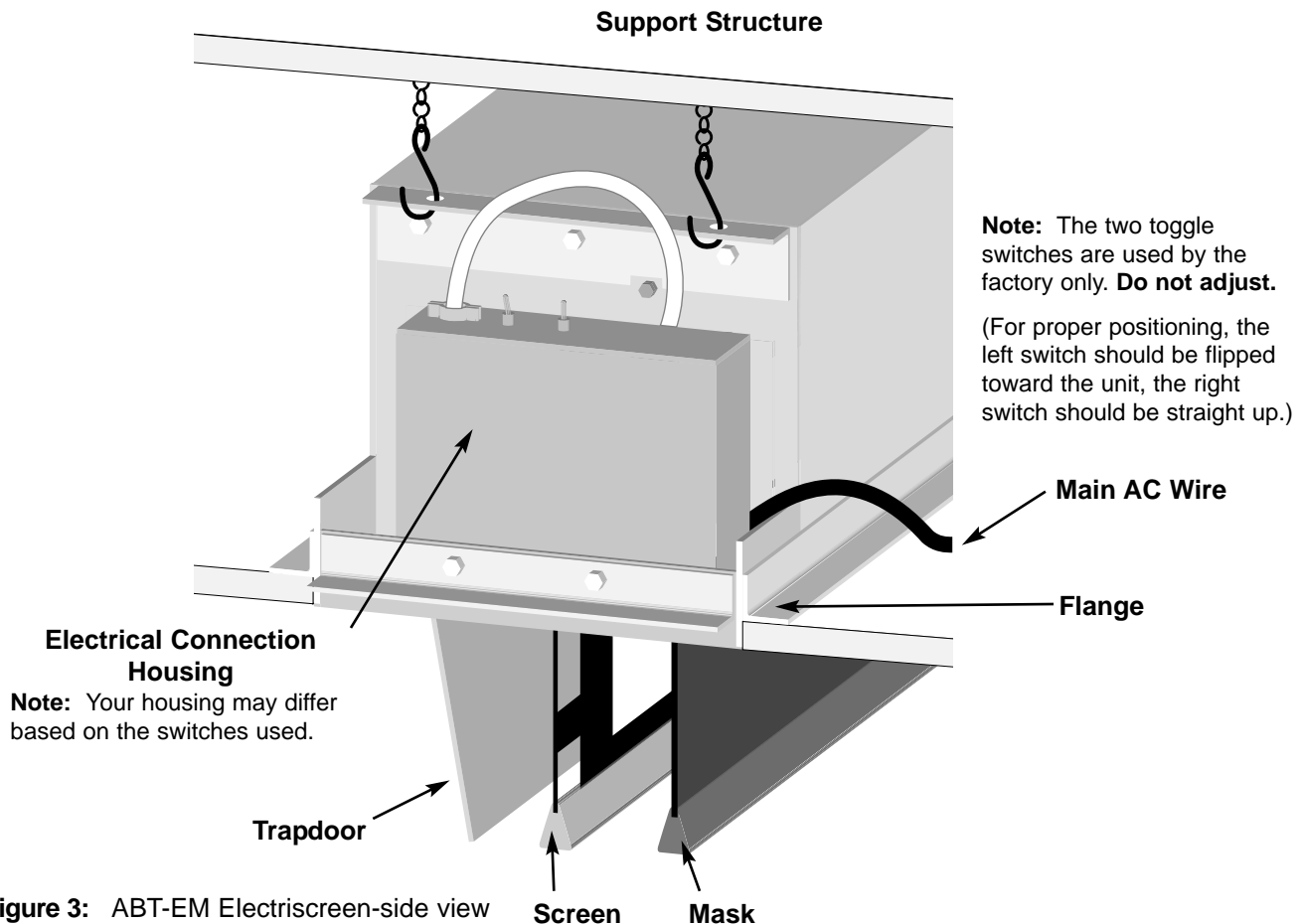

Figure 3: ABT-EM Electriscreen-side view

STEP 2. ELECTRICAL HOOK-UP

The ABT-EM Electriscreen has two roller tubes within the screen unit—one for the main screen and one for the mask. Each roller has its own motor and functions independently.

Caution

Professional techniques should be used when making any electrical connection. A qualified electrician should perform these procedures.

Be sure to follow all standard safety procedures for installing electrical devices.

Do not disassemble or alter the configuration of the motor or the unit's electrical connections. This may cause injury to you or damage to the product.

The electrical connection should be made only to the type of power source indicated on the marking label.

The motor requires standard AC input (unless an alternate voltage has been specified).

There are several kinds of switch controls available. Follow the installation procedure for the type of switch control you will install.

General suggestions for wiring:

- ◆ Soldering is recommended.
- ◆ The use of wire nuts is acceptable.
- ◆ On models not provided with armored whip, a romex connector should be installed in the appropriate electrical KO (Knock Out).

Preparation—Removing access panel

All connections are made to the electrical box on the side of the unit (audience left). An access panel covers the electrical connections. To remove the access panel on the underside of the unit, remove the two hex screws. Refer to Figure 4. Replace the access panel after the electrical connections have been made.

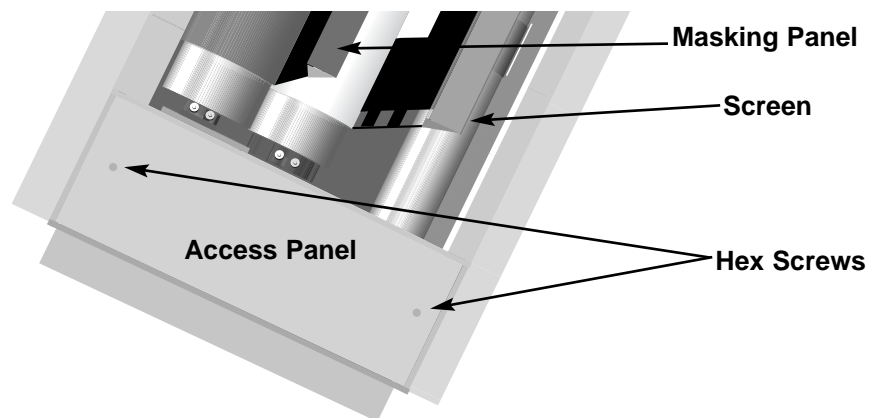

Figure 4: ABT-EM Electriscreen-underside view

Installing the low-voltage 3-button switches (horizontal)

There are three low-voltage controls mounted on a board. Each low-voltage control allows the use of low-voltage wire to connect to the supplied 3-position 24V momentary wall switch. The top low-voltage box controls the mask, the middle box controls the screen, and the bottom box, nearest the J-boxes, controls the door. Refer to Figure 5.

Note: The board can be mounted near the screen, or by adding extra cable, you can mount it farther away.

Preparing the connection

Before making the electrical connections, you need:

- ◆ An available AC constant power source
- ◆ A 4-conductor switch hook-up cable (4-conductor bell wire or category 5 cable is typically used for long runs)
- ◆ Cat 5, multi-conductor unshielded, or similar type electronic cable can be used to connect the 3-button switch to the LVC. The recommended wire gauge is 20 to 24 AWG. Use plenum-rated cable when required.

Making the connection

Figure 6, on the following page, illustrates the connections.

Note: The electrical housing has a 2-gang J-box. For a top view, refer to Figure 4.

1. Connect the 8-conductor cable to the connection harness coming from the J-box labeled “switch input” on the screen unit.

Note: Use a longer cable to mount the low-voltage control board further from the screen unit.

2. Connect the 4-conductor cable to the connection harness coming from the low-voltage control board.
3. Connect the hookup cable to the 3-button switch.
4. Connect the main AC power source to the the low-voltage board.
5. Connect the main AC power source to the the J-box labeled “main AC power connection” on the screen unit.
6. A parallel connection to an outboard audio-visual switching network can be made at this time. (optional)

Caution

Refer to the *First Time Activation* note in the section “Operating the Screen.”

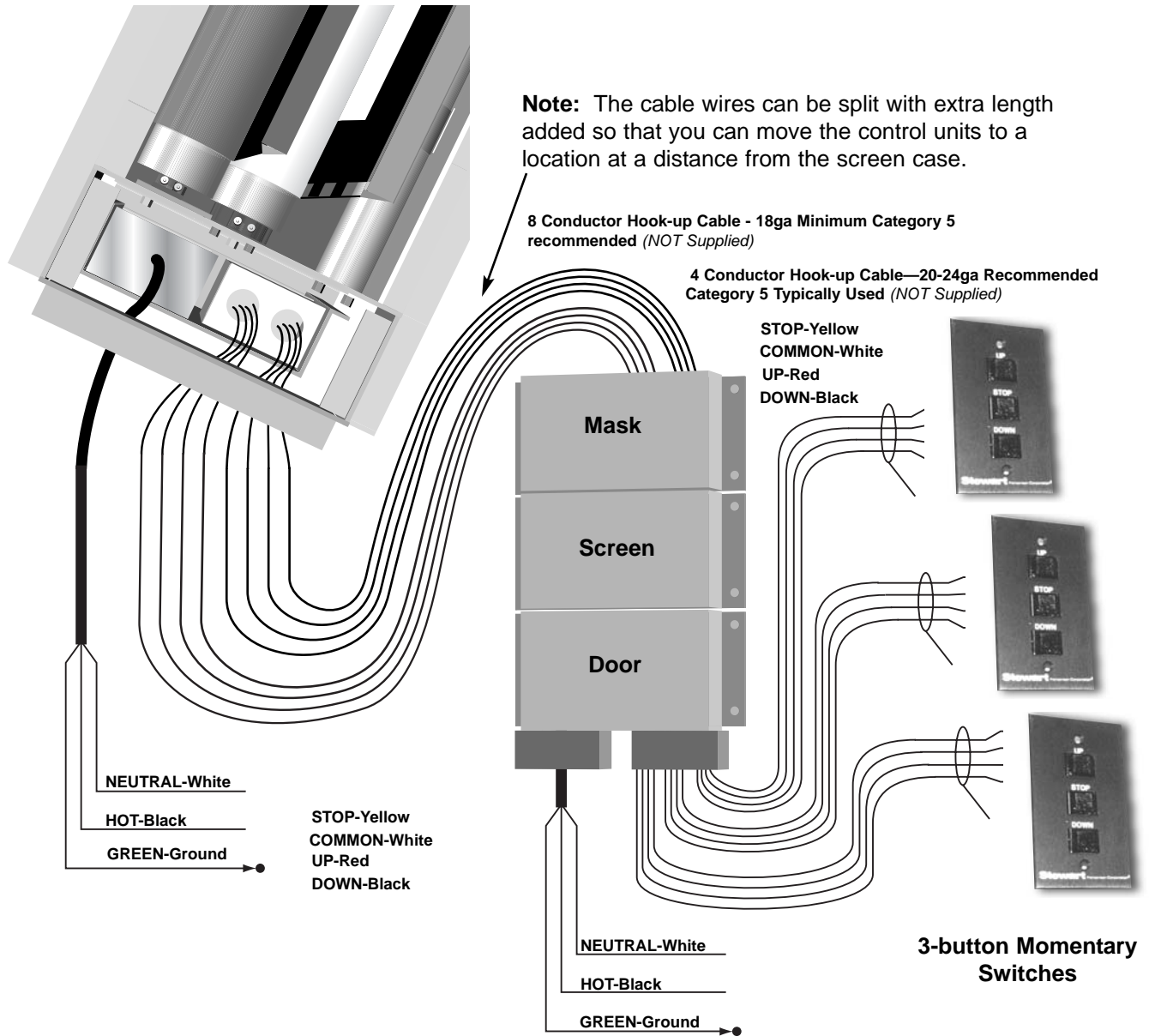

Figure 5: Low voltage 3-button switch wiring

Connecting the dual screen trigger interface option (vertical masking)

Note: The dual screen trigger interface option is *not* available for the horizontal masking system.

Caution

Refer to the *First Time Activation* note in the section “Operating the Screen.”

The optional 12V screen trigger interface enables up and down operation of the screen and mask in conjunction with a projector, tuner, VCR, cable box, or switched AC outlet.

Once the AC power outlet is installed near the screen, an electrician is not needed to connect the screen trigger interface to the power source.

Note: An optional 12V DC transformer is used if there is no 12V power source from the projector or AV control center.

Preparing the connection

Before making the electrical connections, you need:

- ◆ An available AC constant power source installed near the screen

Making the connection

Figure 6 illustrates the connections.

1. Attach each 12V trigger wire to the jack on the box.
2. Connect the main AC power source to the the J-box labeled “main AC power connection.”

Note: The two toggle switches on the electrical connection housing are used by the factory only. **Do not adjust.**

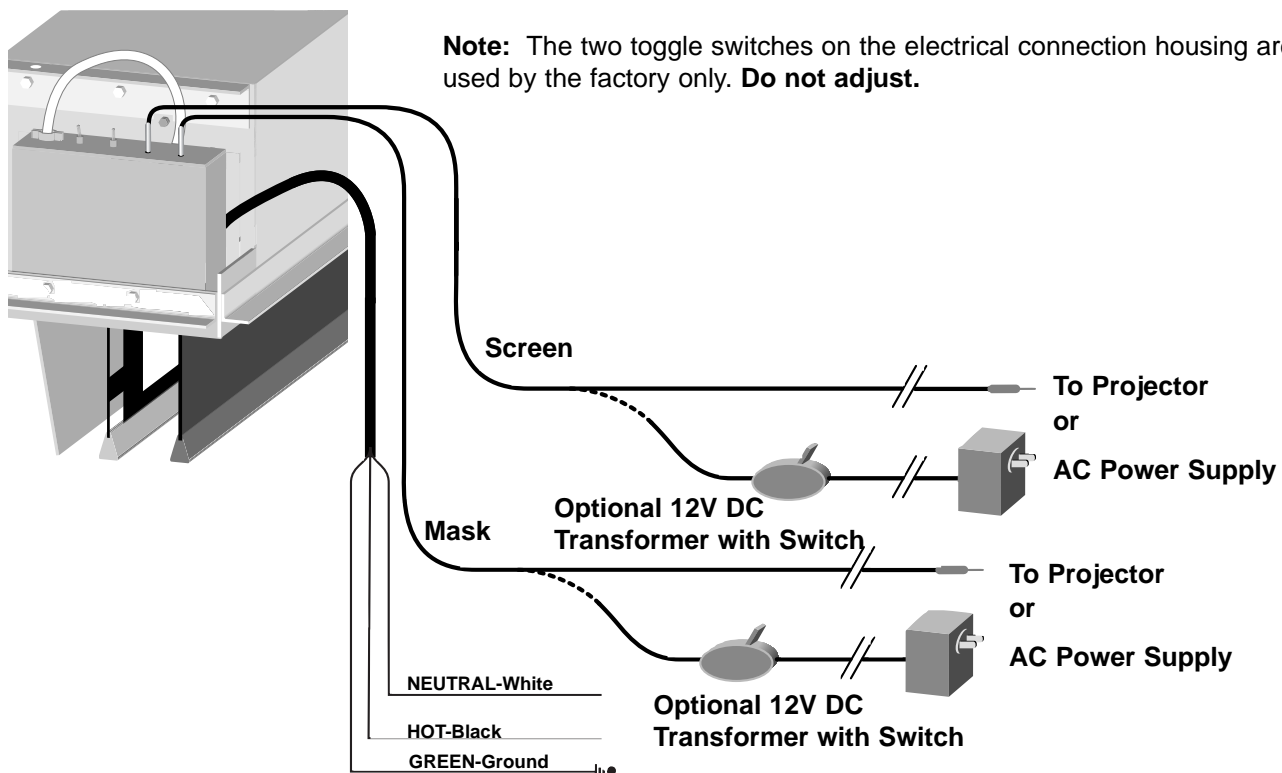

Figure 6: Dual screen trigger interface connection

Connecting the screen trigger interface and low-voltage option (vertical masking)

The optional 12V screen trigger interface enables up and down operation of the door and screen in conjunction with a projector, tuner, VCR, cable box, or switched AC outlet. The low-voltage control switch controls the vertical masking panels.

An optional infrared sensor can be installed with the low-voltage control box. This allows an infrared remote control to adjust the vertical masking panels.

Note: An optional 12V DC transformer is used if there is no 12V power source from the projector or AV control center.

Preparing the connection

Before making the electrical connections, you need:

- ◆ An available AC constant power source installed near the screen
- ◆ A 4-conductor switch hook-up cable (4-conductor bell wire or category 5 cable is typically used for long runs)
- ◆ Cat 5, multi-conductor unshielded, or similar type electronic cable can be used to connect the 3-button switch to the LVC. The recommended wire gauge is 20 to 24 AWG. Use plenum-rated cable when required.

Making the connection

Figure 7 illustrates the connections.

1. Attach the 12V trigger wire to the jack on the box.
2. Connect the main AC power source to the the J-box labeled "main AC power connection."
3. Connect the 4-conductor cable to the connection harness coming from the J-box labeled "switch input."
4. Connect the hookup cable to the 3-button switch.

Caution

Refer to the First Time Activation note in the section "Operating the Screen."

Note: The two toggle switches on the electrical connection housing are used by the factory only. **Do not adjust.**

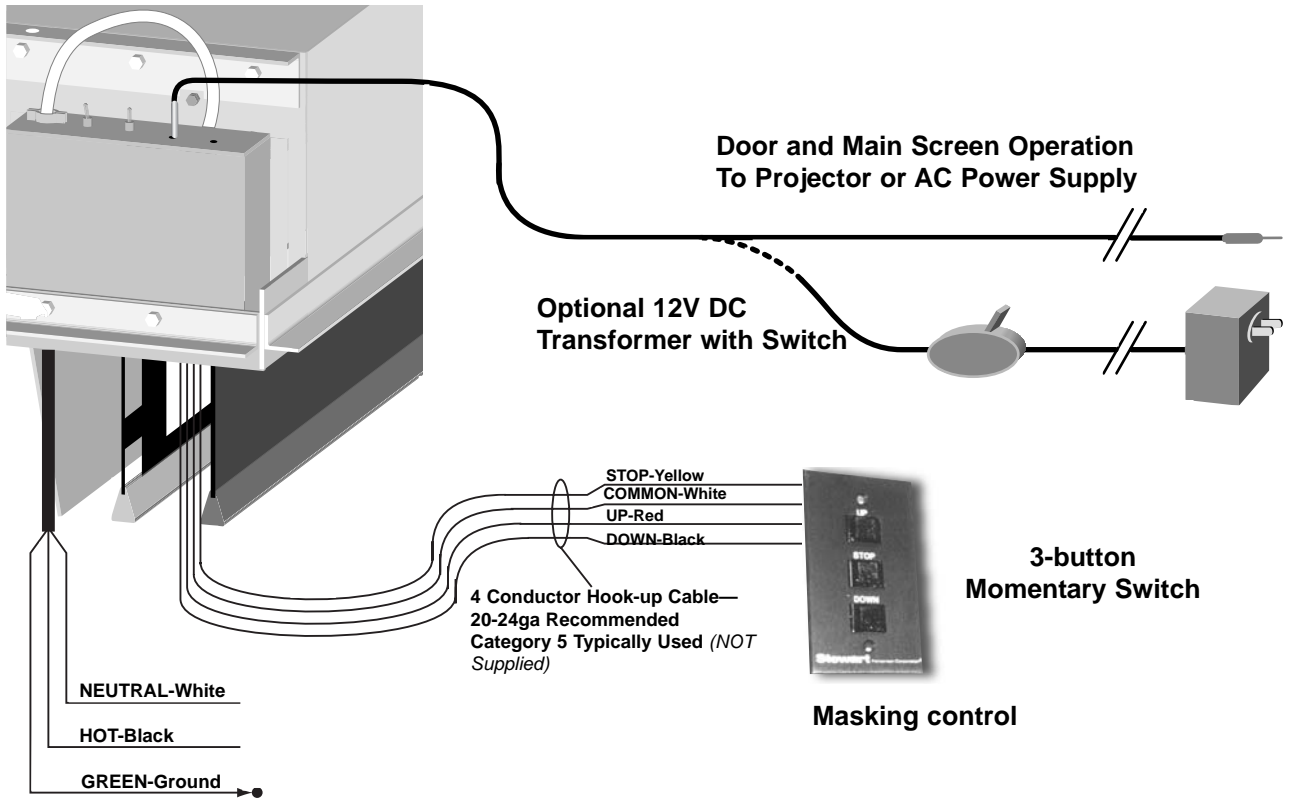

Figure 7: Screen trigger interface and low-voltage connections for vertical masking unit

Connecting the high-voltage switch control (vertical masking)

A standard 3-position AC wall switch is supplied. The high-voltage control is connected to the electrical source. It alternates directions of mask motion by means of the hot lead, using the 3-position switch.

Preparing the connection

Before making the electrical connections, you need:

- ◆ An available AC constant power source
- ◆ A 4-conductor romex or motor connector cable

Making the connections

Figure 8 illustrates the connections.

1. Connect the wall switches to the AC constant power source.
2. Connect the wall switches to the unit's electrical box.

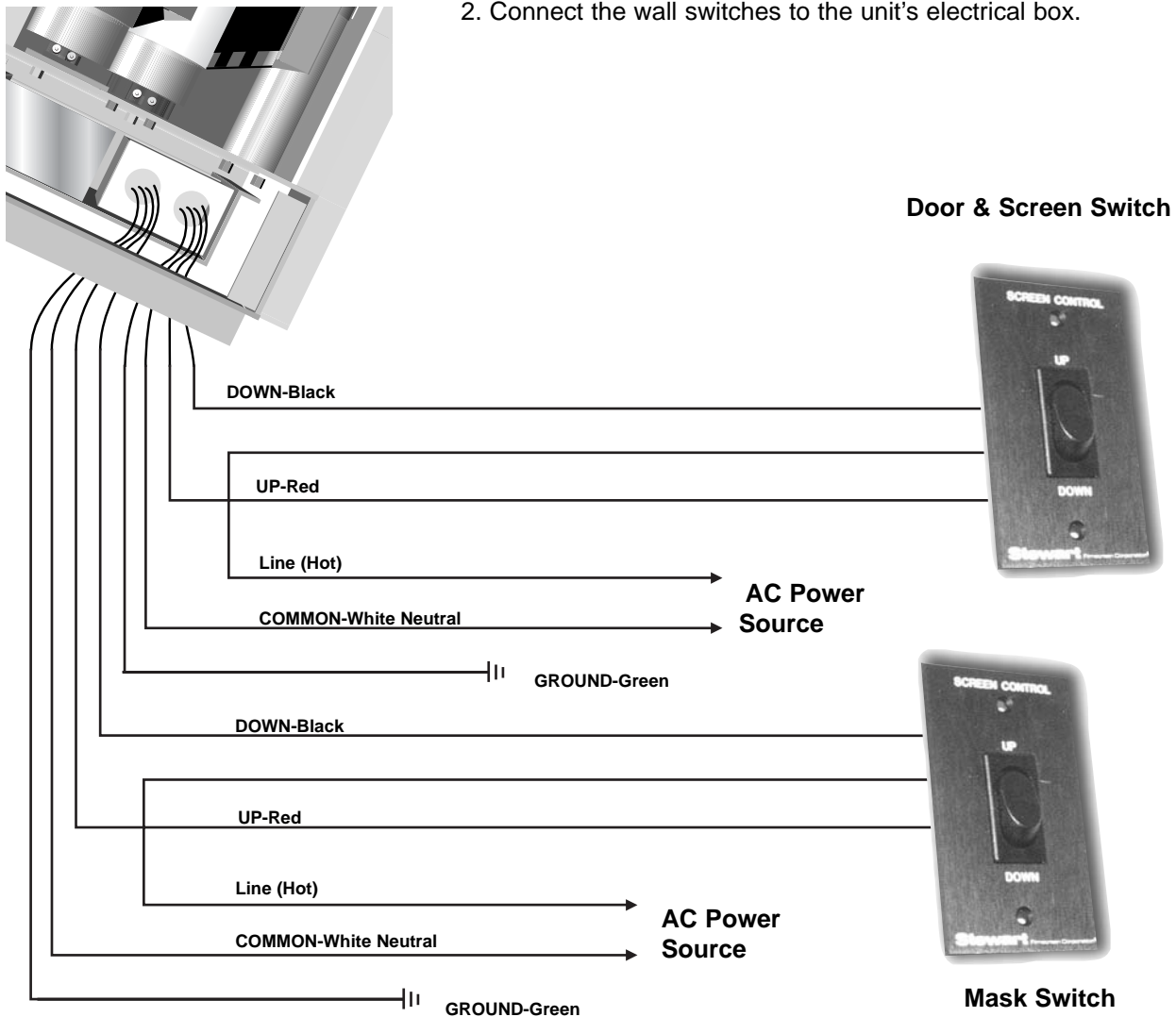

Figure 8: High voltage control wiring diagram

OPERATING THE SCREEN

First time operation

The first time you operate the screen, the protective paper will fall out as the screen unrolls. Once the screen is fully displayed, make sure that no packing paper remains on the screen roll. The screen can be damaged if loose paper remains.

First time activation for screen trigger interface

The STI input must be supplied with 12V DC power before the main AC power is activated. Due to factory screen packing procedures, the main screen roller may not be in the fully up (motor off) position.

First time activation for horizontal screen

You must remove the shipping lockdown brackets. To do this, operate the screen so that the door opens, then stop the operation. Unscrew and remove the shipping lockdown brackets.

Caution

Do not operate the motors when any of the following occurs:

- ◆ The unit emits any smoke, heat, abnormal noise or unusual odor.
- ◆ The unit is damaged in some way, such as damage from a water leak.

If any of these situations occur, call a qualified service person.

The method you use to raise and lower the screen and mask depends on the type of switch control device you have selected.

Use the masking screen as needed to establish the appropriate viewing format.

When you lower or retract the screen or mask, they will stop at their preset limits. If an obstacle (such as a person or furniture) gets in the path of the screen as it is lowered, you should use the switch control to stop the screen's motion; it will not automatically stop if it hits an obstacle.

The motor is designed to be used for short operations such as lowering the screen (or mask) in preparation for viewing. The motor is not designed for continuous duty. If the motor operates continually for more than a few minutes, it may automatically shut off to prevent damage from overheating. If the motor occasionally needs to be run more than normal, for example during initial setup and positioning, allow time for the motor to cool down.

In general, when the screen is not in use, you should store it in the fully retracted position.

ADJUSTING THE SCREEN EXTENSION

Caution

Improper adjustment of the limit switches can cause irreparable damage to the screen itself, resulting in voiding the factory warranty.

Each roller tube has a set of limit switches. The extension and retraction limit switches have been preset at the factory. In general, we advise you to avoid readjusting these switches.

In some cases, to enable proper alignment of the displayed image on the screen, you may need to adjust the extension of the screen or the mask. If adjustment to the extension is necessary, carefully follow these instructions.

Warning!

The screen and mask are fully retracted when the battens are flush with the bottom of the case. Do not attempt adjustments with the yellow retraction (UP) limit switch that will further retract the screen. Incorrect adjustment of the switch will cause severe screen damage. Please consult the factory if you have any questions.

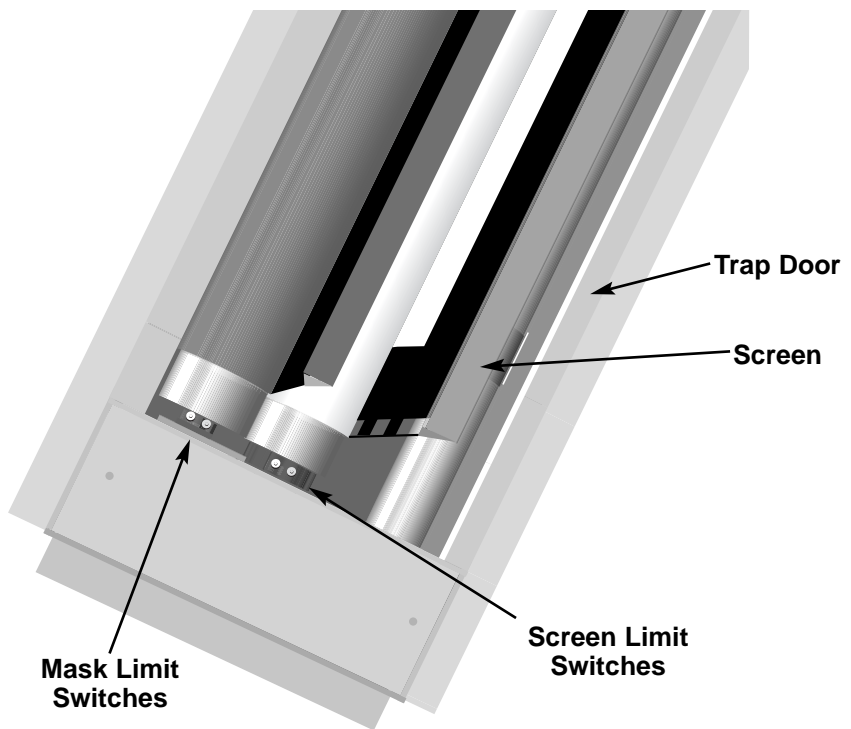

Figure 9: Underside view

Modifying the extension of the screen and the mask

You can increase the extension of the screen and mask up to 3" / 7.6 cm past the factory preset stop, or you can decrease the extension by approximately 4-6" (10 - 15 cm) from the factory preset stop. Do not attempt to modify the screen extension beyond these recommended amounts.

The limit switches are located on the left side of the screen roller tube inside the case, as shown in Figure 9.

To increase the screen's fully extended (screen down) stop position:

1. Lower the screen or mask to its current stop position.
2. Locate the white extension (down) limit switch located on the left side of the screen tube. Use a screwdriver to turn the switch in a counterclockwise direction. If the power is on, the screen will drop incrementally as the switch is turned.

Note: One complete turn of the switch will make approximately a 3/4" (2 cm) change in the screen or mask's stop position.

To decrease the screen extension:

1. Lower the screen or mask until it is extended about halfway down.
2. Locate the white extension (down) limit switch located on the left side of the screen tube. Use a screwdriver to turn the switch in a clockwise direction.

Note: One complete turn of the switch will make approximately a 3/4" (2 cm) change in the screen or mask's stop position.

3. Activate the screen in the down direction until it reaches the newly reduced stop position. Repeat this procedure until the desired stop position is reached.

Once you have made the adjustment, whenever you lower the screen or mask, it will automatically stop at the new position.

Note: It is recommended that you make a note of any changes made to the factory preset.

SCREEN CARE AND CLEANING

With reasonable care, you may expect many years of trouble-free use of your Stewart projection screen.

We encourage you to keep your screen clean. To protect your screen when it is not in use, store it in the fully retracted position.

Avoid getting any foreign material on the screen, as cleaning may prove very difficult. It may not be possible to remove scratches, paint, ink, etc.

General maintenance

The screen surface on your screen is delicate. Special attention to these instructions should be followed when cleaning.

- ◆ A draftsman-style brush may be used to lightly whisk away any loose dirt or dust particles. (This type of brush is usually available at office supply stores.) Stewart Filmscreen has an optional screen cleaning kit that contains the proper type of brush. Contact your dealer if you would like to obtain this cleaning kit.
- ◆ Particles left on the screen when it is retracted into the case may form an impression on the screen surface. Periodically wipe the back of the screen with a clean damp cloth.
- ◆ For tougher spots, use a solution of mild detergent and water. Rub lightly using a sponge. Blot with a damp sponge to absorb excess water. Residual water marks will evaporate within a few minutes. Let the screen air dry completely before retracting.

Do not use any other cleaning materials on the screen. Contact the factory if you have questions about removing difficult spots.

Replacement parts and service

No user-serviceable parts are contained within the unit. Contact your dealer or the factory if you require part replacement or service.

PRODUCT WARRANTY

This warranty covers defects in materials and workmanship for a period of one (1) year from the date of installation, not to exceed fifteen (15) months from the date of shipment, provided this product is installed in a normal environment and maintained according to written instructions in the product Owner's Manual. Stewart Filmscreen warrants against loss of usefulness, discoloration or deterioration of optical quality within the warranty period as a result of manufacturing or material defects.

A factory authorized returned screen arriving prepaid to our facility for inspection and proved defective due to an inherent manufacturing fault will be repaired or replaced by Stewart Filmscreen Corp. This warranty expressly does not cover any costs of removal, installation, framing, or other incidental costs to replacing the screen or returning it to the manufacturer.

Should you encounter a perceived product fault or problem, contact your dealer regarding application of this warranty.

TROUBLESHOOTING

Refer to the following guidelines if you encounter a difficulty in the operation of your Stewart Filmscreen. Problems related to electrical or motor function may require a qualified service person or electrician.

Should you have a problem that is not addressed here, call the Stewart Filmscreen Corporation.

Problem description	Probable cause	Action to take
Door won't open. Screen won't operate.	No AC power available. Outboard switching problem.	Check to see if the circuit breaker has switched off. Reset if needed. Check outboard switching apparatus. Check voltage availability. Contact an electrician. Check that the toggle switches are in the correct position. See Figure 3, p. 5.
Screen or mask won't roll up or down (even though power is available).	Bad connection at switch. Polarity of STI line may be bad.	Have an electrician or qualified service person check the connection as follows: <ul style="list-style-type: none"> · If you have a <i>low voltage control</i> unit, check switch-line connections. · If you have a <i>high voltage control</i> switch, check switch-line connections. · If you have a <i>screen trigger interface</i>, check line connections, or the mini-plugs at the screen input or projector output. Check 12V DC line for correct polarity. Contacts may be sticking—tap relay to free contacts.
Roller tube motors chatter when power is activated.	Can be caused by voltage drop, bad connections, or a defective switch.	Have an electrician or qualified service person check all hook-ups including all outboard wiring.
Unit hums in up mode. (Screen or mask has already retracted.)	The screen batten is retracting too far into the case. Failure to correct can damage motor and screen. Do not use the unit until this problem is resolved.	Have a qualified service person adjust the yellow UP limit switch. Turn the adjusting screw clockwise.
Screen or mask drops when up direction is activated (grinding noise occurs).	Drop in voltage.	Motors require full voltage. Have an electrician or qualified service person check available voltage.
Screen or mask continues past bottom stop position.	White limit switch is out of adjustment.	Readjust the white DOWN limit switch. See pp. 14-15 of this manual.
Battens retract too far into case.	Yellow limit switch out of adjustment. Failure to correct can damage motor and screen. Do not use the unit until this problem is resolved.	Have a qualified service person readjust the yellow UP limit switch. See pp. 14-15 of this manual.
Motor shuts off. Motor has been in use for more than 2 minutes.	Motor is designed for short operations (lowering and retracting), not continuous duty. Longer operation, such as during setup and positioning, causes the motor to overheat and shut off.	Allow the motor to cool down. Complete cooling can take an hour or more. Heat gain is cumulative and takes time to dissipate. If motor use is initiated before it has cooled completely, the motor will shut down again when it reaches maximum temperature.
Any controller (e.g., STI, LVC, etc.) fails to operate motor.		
Dirt, finger prints, marks, etc. on screen surface.	Improper handling of screen.	Brush off or use a mild detergent solution with clean rag or cotton swab.
Indentations appear on screen surface.	Debris or particles adhering to screen due to static cling.	Check back of screen; gently brush debris away by hand.

Stewart
Filmscreen Corporation®

www.stewartfilm.com

1-800-762-4999 ♦ Fax (310) 326-6870